

Inventronics Product Catalog

Driving the Lighting Revolution

INVENTRONICS
DRIVING THE LIGHTING REVOLUTION



CONTENTS

About Inventronics

Product Overview	1
Part Number Scheme	2
Company Profile	3
Manufacturing	4
R&D Capability	5
Verification Tests	6

Product Presentation

90-305Vac

EUC-M Series—C.C Compact	7
NEW EUM-D Series—C.P Ultra Compact	9
EUK Series—C.P	11
EUP Series—C.P Switch-Selectable	13
EUG Series—C.P	15
EUG-192D Series—C.P 2-Channel Class 2	17
EUD Series—C.P Controls-Ready	19
EUD-L Series—C.P Ultra Long Life Controls-Ready	21
EUR Series—C.P Circular	23
HUK Series—C.P Vertical	25
EUV Series—C.V	27
NEW LUN Series—C.P NFC	29
LUG Series—C.P Compact	30
LUD Series—C.P Linear	31
NEW EAM Series—C.P 440Vac IOVP	33

NEW : New Product
C.C : Constant-Current
C.P : Constant-Power
C.V : Constant-Voltage

140-305Vac

EDC Series—C.C 440Vac IOVP 34

176-305Vac

LBD Series—C.P Linear 35

EBV Series—C.V 37

 EBV-F Series—C.V Linear 39

EBS Series—C.P Class I / II Controls-Ready 41

198-264Vac

 LMT Series—C.P Non-Isolated Linear 43

342-457Vac

 LNT Series—C.P Non-Isolated Linear 45

180-528Vac

EFD Series—C.P Controls-Ready 46

249-528Vac

ESV Series—C.V 47

ESD Series—C.P Controls-Ready 49

Others

Intelligent Products 51

Surge Protection Devices 53



For More Information
www.inventronics-co.com

Inventronics reserves the right to modify the product spec. described in this manual, without prior notice. Before ordering, please contact our sales for the latest spec.

Outdoor LED Drivers

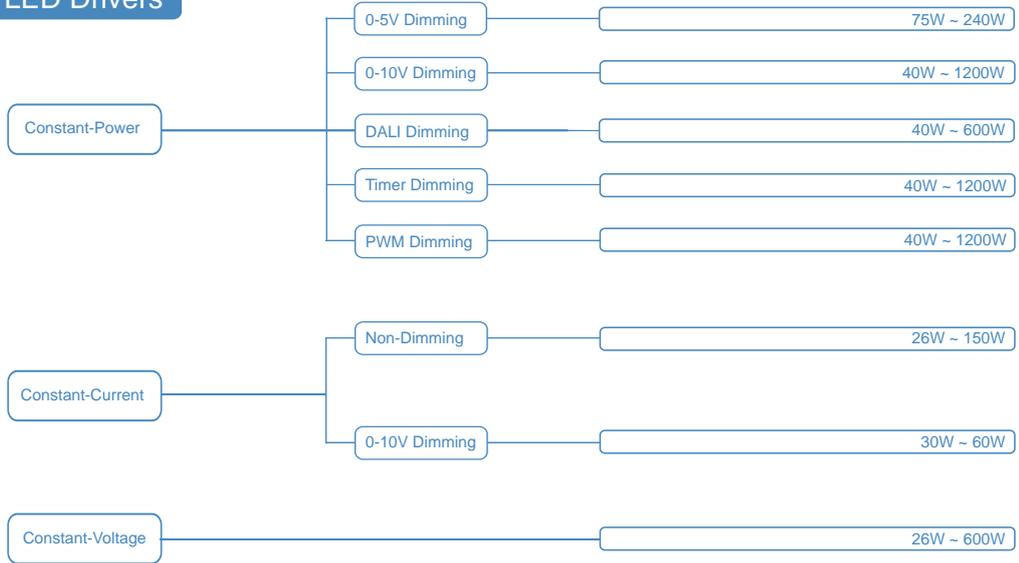

Indoor LED Drivers

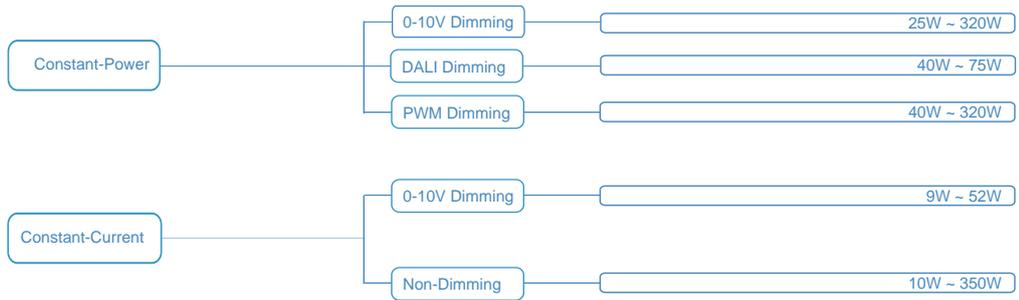

Intelligent Products

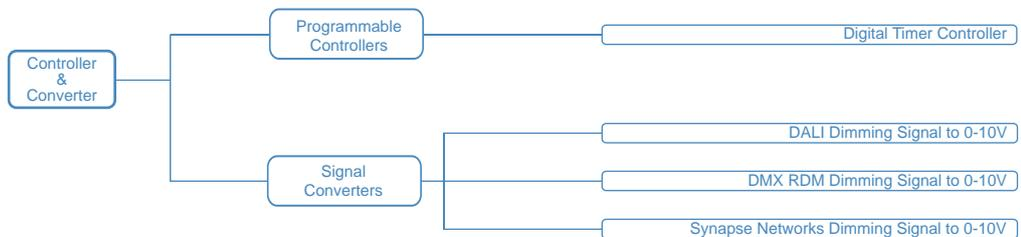

E U D - 150 S 105 D T A

Series 1 Alpha Character

E	Outdoor LED Drivers
L	Indoor LED Drivers
H	Industrial LED Drivers

Input Range 1 Alpha Character

U	90-305Vac
A	90-305Vac with 440Vac IOVP
L	90-132Vac
D	140-305Vac
H	176-264Vac
B	176-305Vac
F	180-528Vac
S	249-528Vac
T	312-528Vac
M	198-264Vac
N	342-457Vac

Type 1 Alpha Character

V	Constant-Voltage Output
C	Constant-Current Output
D/G/K	Adjustable Output Current with Digital Interface
B	Adjustable Output Current with Potentiometer
R	Round Shape Design with AOC Function
S	Short Case with Push Terminals
P	Switch-Selectable Adjustable Output Current
T	Adjustable Output Current with Resistor
M	Multiple Variances with AOC Function
N	Adjustable Output Current with NFC

Output Power 3 Numeric Characters

1K2	1200W
150	150W
075	75W

No. of Outputs 1 Alpha Character

S	Single
D	Dual
T	Triple
Q	Quad
P	Pentad
H	Hexad

Output Voltage/Current 3 Numeric Characters

500	500V	12A	12~12.9A
200	200V	999	9.99A
050	50V	140	1400mA
025	25V	105	1050mA
2V5	2.5V	070	700mA
		035	350mA

Case & Application Feature 1 Alpha Character

	First Generation for Indoor/Outdoor Products
2	Second Generation for Indoor Products
A	Second Generation for Outdoor Products
M	Outdoor/Indoor Metal Case (Normal Rectangle)
Y	Outdoor/Indoor Extremely Cold Application down to -55°C
F	Outdoor/Indoor Long and Slim Metal Case
C	Outdoor/Indoor High Accuracy Output Current
P	Indoor Standard Plastic Case
E	Outdoor/Indoor Terminal Block
W	Independent Indoor Standard Plastic Case with Terminal Block
L	Outdoor/Indoor Long Lifetime
G	Indoor Studs Box Type

Input Cable Indicator 1 Alpha Character

S	Standard, 2 Pin, UL
T	Standard, 3 Pin, UL
D	Standard, 2 Pin, VDE
V	Standard, 3 Pin, VDE
G	Standard, 3 Pin, Global
B	Standard, 3 Pin, BIS

Options & Modes 1 Alpha Character

S	Non-Dimming Control
R	Triac Dimming Control
D	0-10V with or without 0-5V/PWM/Timer
T	Timer Dimming
B	DALI with or without PWM/AC Dim/Push Dimming/Timer
G	DMX512



Established in 2007, Inventronics is one of the world's top LED driver manufacturers specializing in building innovative, highly reliable and long-life products that are certified compliant to all major international safety and performance standards. We design our own drivers at our headquarters in Hangzhou, China and have specialized teams that focus on low, mid and high-power designs as well as teams for network controls and accessory products. Our drivers are manufactured within our Science and Technology Park in Tonglu, China. We encourage factory visits for a first-hand experience of our commitment to quality.

We provide superior products, exceptional technical support, and best-in-class customer service. We also seek to create value for our customers by working to extend and increase the return on investment for solid-state lighting systems.

COMPANY HISTORY

- 2007 Inventronics established
- 2009 Inventronics USA established
- 2011 Sales revenue exceeding RMB 100 million
- 2012 Launched Intelligent LED Driver and a comprehensive solution for LED power supply
- 2013 Authorized safety lab by American UL CTDP and WTDP
- 2015 Products were sold in more than 50 countries and regions
- 2016 Inventronics Tonglu LED Driver Industrial Park completed, Inventronics EU established
Inventronics listed on the Growth Enterprise Market, and launched its IPO
- 2017 Inventronics East Asia Office established
- 2019 Inventronics India established

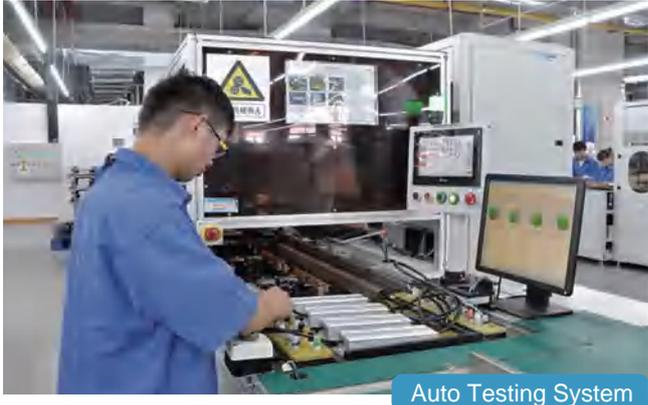

Inventronics' manufacturing facility covers an area of 75,000m². The production line consists of SMT lines, PCBA assembly lines, testing and packaging lines, monitoring equipment and a self-owned Safety and Reliability Testing Labs. Inventronics provides customers with high-quality products that allows us to stay at the forefront of technologies to better empower the next generation of LED luminaires.



As of June, 2019, Inventronics holds 234 authorized patents, 22 US & 108 Chinese & 1 European patents for invention. Relying on its technology and strength of innovation, Inventronics has already built up a portfolio of intellectual property. We are still building upon and strengthening the technology foundation in the LED power supply area in order to maintain our competitiveness.



- Own safety lab conforming to ISO/IEC 17025:2005
- American UL CTDTP and WTDP authorized safety lab
- TÜV Rheinland TMPL authorized safety lab

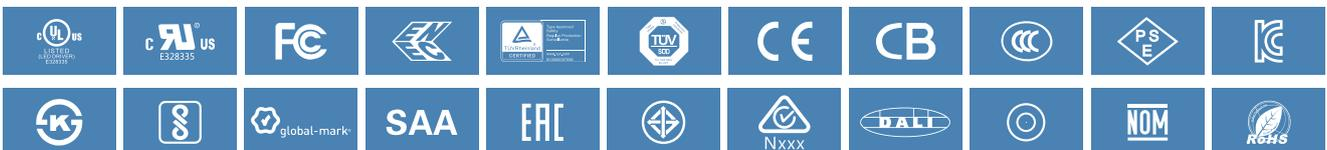



Test Center

Verification Tests

- SVT to ensure product meets specification
- DVT to ensure products are robust
- Thermal Test to verify performance over temperature range
- Lifetime and MTBF Test
- Stress Test to ensure performance at the component level
- EMC Test
- Surge Protection Test
- Environmental Test to verify reliability



Design Verification Test



Surge Test



Thermal Test



Thermal Shock Test



Components Recognition Test



Burn-in Test



» Inventronics Advantages

- High Efficiency (Up to 90.0%)
- Low THD, 10% Max up to 240 Vac
- Constant-Current Output
- Input Voltage Range: 90 ~ 305Vac
- Input UVP and Input OVP
- Input Surge Protection: DM 4kV, CM 6kV
- All-Around Protection: OVP, SCP, OTP
- IP66 / IP67 and UL Dry / Damp Location
- Class 2 & SELV Output
- TYPE HL, for use in a Class I, Division 2 hazardous (Classified) location
- 5-Year Warranty

» About EUC-M

Inventronics low power, IP66 / 67 rated EUC family is ideal for projects that need luminaires at lower levels of brightness without the need for programmability. The EUC family is designed to help improve costs without sacrificing performance and their compact shape offers more flexibility to fit inside a multitude of luminaires. They provide exceptional thermal performance, low THD and higher surge protection.

» Dimming Functions

- Isolated 0-10V (DTM / DVM Models)

» Safety Certifications



» Power Levels

26W 30W 35W 40W 60W

Output Power (W)	Model No.	Full-power Current Range(mA)	Output Voltage Range (Vdc)	Eff.@ 220Vac	Lifetime (hours)	Dimensions (L*W*H)(mm)
26	EUC-026S050STM/SVM0003	350	37 ~ 74	88.50%	84,000 Tc= 70°C	97(80) x 64 x 32
	EUC-026S070STM/SVM0004	500	26 ~ 52	88.00%		
	EUC-026S070STM/SVM0002	600	22 ~ 43	88.00%		
	EUC-026S070STM/SVM	700	20 ~ 37	87.00%		
30	EUC-030S035DTM/DVM	350	37 ~ 75	85.00%	88,000 Tc= 75°C	105(88) x 64 x 32
	EUC-030S050DTM/DVM	500	29 ~ 60	87.00%		
	EUC-030S070DTM/DVM ★	700	20 ~ 43	85.50%		
35	EUC-035S070STM/SVM0004	500	32 ~ 64	87.00%	80,000 Tc= 70°C	97(80) x 64 x 32
	EUC-035S070SVM	700	25 ~ 50	87.00%		
	EUC-035S105STM0007 ★	700	25 ~ 47	86.00%		
	EUC-035S105STM/SVM0004 ★	860	20 ~ 41	86.00%		
	EUC-035S105STM/SVM ★	1050	18 ~ 33	86.00%		
40	EUC-040S070DTM0004	500	40 ~ 80	87.00%	93,000 Tc= 75°C	105(88) x 64 x 32
	EUC-040S070DTM	700	32 ~ 57	86.00%		
	EUC-040S110DTM0005 ★	860	23 ~ 45	86.00%		
	EUC-040S110DTM0001 ★	1050	21 ~ 38	85.00%		
	EUC-040S070DVM0004	500	40 ~ 80	87.00%		
	EUC-040S070DVM	700	32 ~ 57	86.00%		
	EUC-040S105DVM0004	860	23 ~ 47	86.00%		
	EUC-040S105DVM	1050	21 ~ 38	85.00%		
60	EUC-060S070DTM/DVM0004	500	60 ~ 120	90.00%	95,900 Tc= 70°C	112(95) x 64 x 32
	EUC-060S070DTM/DVM	700	48 ~ 86	89.00%		
	EUC-060S105DTM/DVM0004	860	35 ~ 70	89.00%		
	EUC-060S105DTM/DVM	1050	34 ~ 57	89.00%		
	EUC-060S180DTM/DVM0006 ★	1200	25 ~ 50	89.00%		
	EUC-060S180DTM/DVM0004 ★	1400	21 ~ 43	88.00%		
	EUC-060S180DTM/DVM ★	1800	20 ~ 33	87.00%		
	EUC-060S070STM/SVM0004	500	60 ~ 120	90.00%	85,800 Tc= 70°C	112(95) x 64 x 32
	EUC-060S070STM/SVM	700	48 ~ 86	89.00%		
	EUC-060S105STM/SVM0004	860	35 ~ 70	89.00%		
	EUC-060S105STM/SVM	1050	34 ~ 57	89.00%		
	EUC-060S180STM/SVM0006 ★	1200	25 ~ 50	89.00%		
	EUC-060S180STM/SVM0004 ★	1400	21 ~ 43	88.00%		
	EUC-060S180STM/SVM ★	1800	20 ~ 33	87.00%		

★ : Class 2 Model



» Inventronics Advantages

- High Efficiency (Up to 94.0%)
- Full Power at Wide Output Current Range (Constant Power)
- Adjustable Output Current with Programability (Off-Line)
- Input Voltage Range: 90 ~ 305Vac
- Compact Metal Case with Excellent Thermal Performance
- Output Lumen Compensation
- Input Surge Protection: DM 6kV, CM 10kV
- All-Around Protection: OVP, SCP, OTP
- IP66 / IP67 and UL Dry / Damp / Wet Location
- SELV Output
- TYPE HL, for use in a Class I, Division 2 hazardous (Classified) location
- 5-Year Warranty

» About EUM

Inventronics NEW EUM-DG series provides a next generation platform offering an enhanced transformer design, optimized components that provide lower costs without sacrificing quality or performance and a new design methodology. They also utilize a new global cable suitable for world-wide use to help OEMs reduce inventory SKUs.

» Dimming Functions

- Isolated 1-5V / 1-10V / 10V PWM / 3-Timer-Modes

» Safety Certifications



» Power Levels

75W 100W 150W 200W 240W

Output Power (W)	Model No.	Full-power Current Range(mA)	Output Voltage Range (Vdc)	Eff.@ 220Vac	Lifetime (hours)	Dimensions (L*W*H)(mm)
75	EUM-075S105DG/DT/DB	700 ~ 1050	36 ~ 107	90.00%	100,000 Tc= 70°C	142(125) × 60 × 34
	EUM-075S150DG/DT/DB	1050 ~ 1500	25 ~ 72	89.50%		
	EUM-075S210DG/DT/DB ★	1400 ~ 2100	18 ~ 54	89.00%		
100	EUM-100S105DG/DT/DB	700 ~ 1050	48 ~ 143	92.50%	100,000 Tc= 70°C	148(131) × 60 × 34
	EUM-100S150DG/DT/DB	1050 ~ 1500	34 ~ 95	92.00%		
	EUM-100S280DG/DT/DB ★	1750 ~ 2800	17 ~ 54	91.50%		
150	EUM-150S105DG/DT/DB	700 ~ 1050	72 ~ 214	93.00%	106,000 Tc= 70°C	178(161) × 60 × 34
	EUM-150S150DG/DT/DB	1050 ~ 1500	50 ~ 143	93.50%		
	EUM-150S210DG/DT/DB	1400 ~ 2100	36 ~ 107	92.00%		
	EUM-150S420DG/DT/DB	2800 ~ 4200	18 ~ 54	91.50%		
200	EUM-200S105DG/DT/DB	700 ~ 1050	95 ~ 286	93.50%	100,000 Tc= 70°C	188(171) × 60 × 36.5
	EUM-200S150DG/DT/DB	1050 ~ 1500	67 ~ 190	93.00%		
	EUM-200S280DG/DT/DB	1800 ~ 2800	36 ~ 111	92.50%		
	EUM-200S560DG/DT/DB	3500 ~ 5600	18 ~ 57	92.00%		
240	EUM-240S105DG/DT/DB	700 ~ 1050	115 ~ 343	94.00%	100,000 Tc= 70°C	218(201) × 60 × 36.5
	EUM-240S150DG/DT/DB	1050 ~ 1500	80 ~ 229	93.50%		
	EUM-240S350DG/DT/DB	2150 ~ 3500	35 ~ 111	93.00%		
	EUM-240S670DG/DT/DB	4200 ~ 6700	18 ~ 57	92.50%		

★ : Class 2 Model

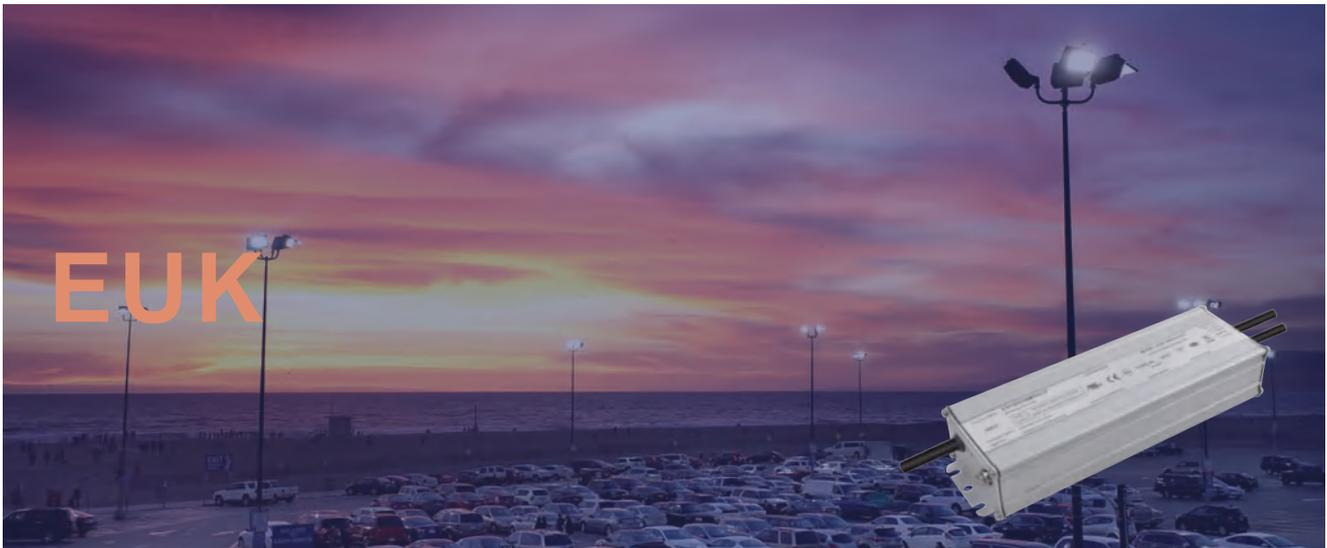

» Inventronics Advantages

- High Efficiency (Up to 93.5%)
- Full Power at Wide Output Current Range (Constant Power)
- Adjustable Output Current with Programability (Off-Line)
- Input Voltage Range: 90 ~ 305Vac
- Input Surge Protection: DM 6kV, CM 10kV
- Class 2 & SELV Output
- All-Around Protection: OVP, SCP, OTP
- IP67 and UL Dry / Damp / Wet Location
- TYPE HL, for use in a Class I, Division 2 hazardous (Classified) location
- 5-Year Warranty

» About EUK

The EUK family of programmable drivers is designed to be a simplified alternative to the EUG and EUD families for applications that do not require enhanced features. Many customers desire dimming, programmability and surge protection but do not require the always-on auxiliary power or the added feature of a multiple timer dimming mode. By removing those features and adding isolated dimming, they now have a simplified product that still offers design flexibility, high efficiency and a reliable performance.

» Dimming Functions

- Isolated 0-10V / 10V PWM (DT / DV Models)
- 3-Timer-Modes (TT / TV Models)

» Safety Certifications



» Power Levels

75W 96W 150W 200W 240W 320W

Output Power (W)	Model No.	Full-power Current Range(mA)	Output Voltage Range (Vdc)	Eff.@ 220Vac	Lifetime (hours)	Dimensions (L*W*H)(mm)
75	EUK-075S070DT/DV/TT/TV	450 ~ 700	54~167	90.50%	84,000 Tc= 70°C	166(145) × 67.5 × 36.5
	EUK-075S105DT/DV/TT/TV	700 ~ 1050	36~107	90.00%		
	EUK-075S175DT/DV/TT/TV	1190 ~ 1750	22 ~ 63	90.00%		
	EUK-075S280DT/DV/TT/TV ★	1900 ~ 2800	14 ~ 39	88.50%		
96	EUK-096S105DT/DV/TT/TV	700 ~ 1050	48 ~ 137	92.00%	100,000 Tc= 70°C	182(161) × 67.5 × 36.5
	EUK-096S150DT/DV/TT/TV	1050 ~ 1500	32 ~ 91	91.00%		
	EUK-096S210DT/DV/TT/TV	1400 ~ 2100	24 ~ 69	91.00%		
	EUK-096S350DT/DV/TT/TV ★	2450 ~ 3500	14 ~ 39	89.00%		
150	EUK-150S105DT/DV/TT/TV	700 ~ 1050	75 ~ 214	93.00%	81,000 Tc= 70°C	192(171) × 67.5 × 36.5
	EUK-150S150DT/DV/TT/TV	1050 ~ 1500	50 ~ 143	93.00%		
	EUK-150S210DT/DV/TT/TV	1400 ~ 2100	38 ~ 107	92.50%		
	EUK-150S350DT/DV/TT/TV	2450 ~ 3500	22 ~ 61	91.50%		
	EUK-150S560DT/DV/TT/TV	3850 ~ 5600	14 ~ 39	90.50%		
200	EUK-200S105DT/DV/TT/TV	700 ~ 1050	95 ~ 286	93.50%	85,000 Tc= 70°C	221(202) × 67.5 × 39.7
	EUK-200S150DT/DV/TT/TV	1050 ~ 1500	67 ~ 190	93.50%		
	EUK-200S210DT/DV/TT/TV	1400 ~ 2100	48 ~ 143	93.00%		
	EUK-200S350DT/DV/TT/TV	2450 ~ 3500	29 ~ 82	93.00%		
	EUK-200S560DT/DV/TT/TV	3850 ~ 5600	18 ~ 52	92.00%		
240	EUK-240S105DT/DV/TT/TV	700 ~ 1050	114 ~ 343	93.50%	84,000 Tc= 70°C	233(212) × 67.5 × 39.7
	EUK-240S150DT/DV/TT/TV	1050 ~ 1500	80 ~ 229	93.50%		
	EUK-240S210DT/DV/TT/TV	1400 ~ 2100	57 ~ 171	93.50%		
	EUK-240S420DT/DV/TT/TV	2800 ~ 4200	29 ~ 86	92.50%		
	EUK-240S670DT/DV/TT/TV	4600 ~ 6700	18 ~ 52	92.00%		
320	EUK-320S150DT/DV/TT/TV	1050 ~ 1500	107 ~ 305	93.50%	86,000 Tc= 70°C	251(224) × 80 × 39.7
	EUK-320S220DT/DV/TT/TV	1540 ~ 2200	73 ~ 208	93.50%		
	EUK-320S320DT/DV/TT/TV	2240 ~ 3200	50 ~ 143	92.50%		
	EUK-320S460DT/DV/TT/TV	3220 ~ 4600	35 ~ 100	92.50%		
	EUK-320S670DT/DV/TT/TV	4690 ~ 6700	24 ~ 68	92.50%		

★ : Class 2 Model



» Inventronics Advantages

- High Efficiency (Up to 93.5%)
- Full Power at Wide Output Current Range (Constant Power)
- Switch-Selectable Adjustable Output Current (Off-Line)
- Input Voltage Range: 90 ~ 305Vac
- Input Surge Protection: DM 6kV, CM 10kV
- All-Around Protection: OVP, SCP, OTP
- IP67 and UL Dry / Damp / Wet Location
- Class 2 & SELV Output
- TYPE HL, for use in a Class I, Division 2 hazardous (Classified) location
- 5-Year Warranty

» About EUP

Inventronics EUP family of switch-selectable drivers is designed to be a simple, IP67 rated alternative to the EUK and EUG families for applications that do not require dimming controls. Equipped with a dip-switch the EUP family allows you to achieve optimal results and various current configurations without the need of a programming tool.

» Safety Certifications



» Power Levels

75W 96W 150W 200W 240W 320W

Output Power (W)	Model No.	Full-Power Current Range(mA)	Output Voltage Range (Vdc)	Eff.@ 220Vac	Lifetime (hours)	Dimensions (L*W*H)(mm)
75	EUP-075S070ST/SV	450 ~ 700	54 ~ 167	91.00%	79,000 Tc= 70°C	166(145) × 60 × 36.5
	EUP-075S105ST/SV	700 ~ 1050	36 ~ 107	91.00%		
	EUP-075S175ST/SV	1190 ~ 1750	22 ~ 63	90.50%		
	EUP-075S180ST ★	1400 ~ 1800	22 ~ 54	90.50%		
	EUP-075S280ST/SV ★	1900 ~ 2800	14 ~ 39	89.50%		
96	EUP-096S070ST/SV	450 ~ 700	74 ~ 213	93.00%	77,000 Tc= 70°C	182(161) × 60 × 36.5
	EUP-096S105ST/SV	700 ~ 1050	48 ~ 137	93.00%		
	EUP-096S150ST/SV	1050 ~ 1500	32 ~ 91	92.50%		
	EUP-096S210ST/SV	1400 ~ 2100	24 ~ 69	92.00%		
	EUP-096S215ST ★	1750 ~ 2150	24 ~ 55	92.00%		
	EUP-096S350ST/SV ★	2625 ~ 3500	14 ~ 36	91.50%		
150	EUP-150S070ST/SV	450 ~ 700	117 ~ 333	93.00%	114,000 Tc= 70°C	192(171) × 60 × 36.5
	EUP-150S105ST/SV	700 ~ 1050	75 ~ 214	93.00%		
	EUP-150S150ST/SV	1050 ~ 1500	50 ~ 143	92.50%		
	EUP-150S210ST/SV	1400 ~ 2100	38 ~ 107	93.00%		
	EUP-150S350ST/SV	2450 ~ 3500	22 ~ 61	92.50%		
	EUP-150S560ST/SV	4200 ~ 5600	14 ~ 36	92.00%		
200	EUP-200S105ST/SV	700 ~ 1050	95 ~ 286	93.50%	85,000 Tc= 70°C	221(202) × 67.5 × 39.7
	EUP-200S150ST/SV	1050 ~ 1500	67 ~ 190	93.50%		
	EUP-200S210ST/SV	1400 ~ 2100	48 ~ 143	93.00%		
	EUP-200S350ST/SV	2450 ~ 3500	29 ~ 82	93.00%		
	EUP-200S560ST/SV	3850 ~ 5600	18 ~ 52	92.00%		
240	EUP-240S105ST/SV	700 ~ 1050	114 ~ 343	93.50%	84,000 Tc= 70°C	233(212) × 67.5 × 39.7
	EUP-240S150ST/SV	1050 ~ 1500	80 ~ 229	93.50%		
	EUP-240S210ST/SV	1400 ~ 2100	57 ~ 171	93.50%		
	EUP-240S420ST/SV	2800 ~ 4200	29 ~ 86	92.50%		
	EUP-240S670ST/SV	4600 ~ 6700	18 ~ 52	92.00%		
320	EUP-320S150ST/SV	1050 ~ 1500	107 ~ 305	93.50%	78,000 Tc= 70°C	251(224) × 80 × 42
	EUP-320S220ST/SV	1500 ~ 2200	73 ~ 213	93.50%		
	EUP-320S320ST/SV	2300 ~ 3200	50 ~ 139	92.50%		
	EUP-320S460ST/SV	3200 ~ 4600	35 ~ 100	92.50%		
	EUP-320S670ST/SV	4700 ~ 6700	24 ~ 68	92.50%		

★ : Class 2 Model



» Inventronics Advantages

- Ultra High Efficiency (Up to 94.0%)
- Full Power at Wide Output Current Range (Constant Power)
- Adjustable Output Current with Programmability (Off-Line)
- Input Voltage Range: 90 ~ 305Vac
- Input Surge Protection: DM 6kV, CM 10kV
- All-Around Protection: OVP, SCP, OTP
- IP67 and UL Dry / Damp / Wet Location
- Class 2 & SELV Output
- TYPE HL, for use in a Class I, Division 2 hazardous (Classified) location
- 7-Year Warranty

» About EUG

Inventronics programmable EUG family offers simple output-current adjustment to optimize luminaire performance, while providing full-rated output power over a range of current settings with fewer models to stock. Designed to be a more cost-effective alternative to the EUD family drivers, the EUG family is more compact, more efficient and offers better surge protection.

» Dimming Functions

- 0-5V / 0-10V / PWM / Timer

» Safety Certifications



» Power Levels

75W 96W 150W 200W 240W

Output Power (W)	Model No.	Full-power Current Range(mA)	Output Voltage Range (Vdc)	Eff. @ 220Vac	Lifetime (hours)	Dimensions (L*W*H)(mm)
75	EUG-075S070DT/DV	450 ~ 700	54~167	91.00%	99,000 Tc= 70°C	177(150) × 67.5 × 36.5
	EUG-075S105DT/DV	700 ~ 1050	36~107	90.50%		
	EUG-075S175DT/DV	1190 ~ 1750	22 ~ 63	90.00%		
	EUG-075S180DT ★	1400 ~ 1800	22 ~ 54	90.00%		
	EUG-075S280DT/DV ★	1920 ~ 2800	14 ~ 39	89.00%		
96	EUG-096S070DT/DV	450 ~ 700	74 ~ 213	92.00%	98,000 Tc= 70°C	201(174) × 67.5 × 36.5
	EUG-096S105DT/DV	700 ~ 1050	48 ~ 137	93.00%		
	EUG-096S210DT/DV	1400 ~ 2100	24 ~ 69	92.00%		
	EUG-096S215DT ★	1750 ~ 2150	24 ~ 55	91.50%		
	EUG-096S350DT/DV ★	2450 ~ 3500	14 ~ 39	91.00%		
150	EUG-150S070DT/DV	450 ~ 700	117 ~ 333	93.50%	99,000 Tc= 70°C	209(188) × 67.5 × 39.7
	EUG-150S105DT/DV	700 ~ 1050	75 ~ 214	93.50%		
	EUG-150S210DT/DV	1400 ~ 2100	38 ~ 107	92.50%		
	EUG-150S350DT/DV	2450 ~ 3500	22 ~ 61	92.00%		
	EUG-150S560DT/DV	3850 ~ 5600	14 ~ 39	92.00%		
200	EUG-200S105DT/DV	700 ~ 1050	95 ~ 286	94.00%	95,000 Tc= 70°C	221(200) × 67.5 × 39.7
	EUG-200S210DT/DV	1400 ~ 2100	48 ~ 143	94.00%		
	EUG-200S350DT/DV	2450 ~ 3500	29 ~ 82	93.50%		
	EUG-200S560DT/DV	3850 ~ 5600	18 ~ 52	92.50%		
240	EUG-240S105DT/DV	700 ~ 1050	114 ~ 343	94.00%	109,000 Tc= 70°C	233(212) × 67.5 × 39.7
	EUG-240S210DT/DV	1400 ~ 2100	57 ~ 171	93.00%		
	EUG-240S420DT/DV	2800 ~ 4200	29 ~ 86	93.00%		
	EUG-240S670DT/DV	4450 ~ 6700	18 ~ 54	93.00%		

★ : Class 2 Model



» Inventronics Advantages

- High Efficiency (Up to 92.0%)
- Two Independent Output Channels (Isolated)
- Two Independent Dimming Channels (Isolated)
- Full Power at Wide Output Current Range (Constant Power)
- Adjustable Output Current with Programmability (Off-Line)
- Input Voltage Range: 90 ~ 305Vac
- Input Surge Protection: DM 6kV, CM 10kV
- All-Around Protection: IUVP, OVP, SCP, OTP
- IP67 and UL Dry / Damp / Wet Location
- Class 2 & SELV Output
- TYPE HL, for use in a Class I, Division 2 hazardous (Classified) location
- 5-Year Warranty

» About EUG-192D

The EUG-192D series consists of two-channel UL Class 2 drivers that offer a wide range of programmable output currents that fit seamlessly in new or existing designs. Each channel provides up to 96W, independent dimming controls and independent isolated output. They are ideal for simplifying a high-power luminaire design while reducing the number of inventory SKUs, lowering installation and purchasing costs and providing an easier thermal management.

» Dimming Functions

- Isolated 0-5V / 0-10V / PWM / 3-Timer-Modes

» Safety Certifications



» Power Levels

192W

Output Power (W)	Model No.	Full-power Current Range(mA)	Output Voltage Range (Vdc)	Eff. @ 220Vac	Lifetime (hours)	Dimensions (L*W*H)(mm)
192	EUG-192D105DT/DV	700 ~ 1050	48~137	92.00%	93,000 Tc= 70°C	281(254) x 80 x 42
	EUG-192D265DT/DV ★	1750 ~ 2650	18~54	91.00%		
	EUG-192D400DT/DV ★	2650 ~ 4000	12~36	91.00%		

★ : Class 2 Model



» Inventronics Advantages

- Ultra High Efficiency (Up to 95.0%)
- Full Power at Wide Output Current Range (Constant Power)
- Adjustable Output Current with Programability (Off-Line)
- Input Voltage Range: 90 ~ 305Vac
- Thermal Sensing and Protection for LED Module
- Output Lumen Compensation
- Input Surge Protection: DM 6kV, CM 10kV
- All-Around Protection: OVP, SCP, OTP
- IP67 and UL Dry / Damp / Wet Location
- Always-on Auxiliary Power: 12Vdc, 200mA (Transient Peak Current up to 400mA)
- TYPE HL, for use in a Class I, Division 2 hazardous (Classified) location
- 7-Year Warranty

» About EUD

Inventronics EUD series of Controls-Ready programmable outdoor drivers is designed to provide additional features to existing product lines. Their Dim-to-Off capabilities make them easier to integrate with sensors and control systems providing optimal flexibility. They also offer superior surge protection, better thermal performance and higher efficiency and reliability than most competitors.

» Dimming Functions

- 0-10V / PWM / 3-Timer-Modes (DT / DV / DTA / DVA Models)
- DALI / 3-Timer-Modes (BT / BV / BTA / BVA Models)
- Dim-to-Off with Standby Power ≤ 0.5 W
- Digital Dimming Optional

» Safety Certifications



» Power Levels

75W 96W 150W 200W 240W 320W 480W 600W

Output Power (W)	Model No.	Full-power Current Range(mA)	Output Voltage Range (Vdc)	Eff. @ 220Vac	Lifetime (hours)	Dimensions (L*W*H)(mm)
75	EUD-075S070BT/BV/DT/DV	450 ~ 700	54 ~ 167	91.00%	98,000 Tc= 70°C	182(155) x 67.5 x 36.5
	EUD-075S105BT/BV/DT/DV	700 ~ 1050	36 ~ 107	91.00%		
	EUD-075S175BT/BV/DT/DV	1190 ~ 1750	22 ~ 63	90.50%		
	EUD-075S180DT ★	1400 ~ 1800	22 ~ 54	90.50%		
	EUD-075S280BT/BV/DT/DV ★	1920 ~ 2800	14 ~ 39	89.50%		
96	EUD-096S070BTA/BVA/DTA/DVA	450 ~ 700	74 ~ 213	91.50%	104,000 Tc= 70°C	201(180) x 67.5 x 36.5
	EUD-096S105BTA/BVA/DTA/DVA	700 ~ 1050	48 ~ 137	92.50%		
	EUD-096S210BTA/BVA/DTA/DVA	1400 ~ 2100	24 ~ 69	93.00%		
	EUD-096S215DTA ★	1750 ~ 2150	24 ~ 55	92.50%		
	EUD-096S350BTA/BVA/DTA/DVA ★	2450 ~ 3500	14 ~ 39	91.00%		
150	EUD-150S105BTA/BVA/DTA/DVA	700 ~ 1050	75 ~ 214	94.00%	100,000 Tc= 70°C	225(204) x 67.5 x 39.7
	EUD-150S210BTA/BVA/DTA/DVA	1400 ~ 2100	38 ~ 107	94.00%		
	EUD-150S350BTA/BVA/DTA/DVA	2450 ~ 3500	22 ~ 61	93.50%		
	EUD-150S560BTA/BVA/DTA/DVA	3850 ~ 5600	14 ~ 39	92.50%		
200	EUD-200S105BTA/BVA/DTA/DVA	700 ~ 1050	95 ~ 286	94.50%	108,000 Tc= 70°C	231(210) x 67.5 x 39.5
	EUD-200S210BTA/BVA/DTA/DVA	1400 ~ 2100	48 ~ 143	94.00%		
	EUD-200S350BTA/BVA/DTA/DVA	2450 ~ 3500	29 ~ 82	93.50%		
	EUD-200S560BTA/BVA/DTA/DVA	3850 ~ 5600	18 ~ 52	93.00%		
240	EUD-240S105BTA/BVA/DTA/DVA	700 ~ 1050	114 ~ 343	94.00%	96,000 Tc= 70°C	240(219) x 67.5 x 39.7
	EUD-240S150BTA/BVA	1050 ~ 1500	80 ~ 229	93.00%		
	EUD-240S210BTA/BVA/DTA/DVA	1400 ~ 2100	57 ~ 171	93.50%		
	EUD-240S420BTA/BVA/DTA/DVA	2800 ~ 4200	29 ~ 86	93.00%		
	EUD-240S670BTA/BVA/DTA/DVA	4450 ~ 6700	18 ~ 54	93.00%		
320	EUD-320S150BT/BV/DT/DV	1050 ~ 1500	107 ~ 305	94.00%	97,000 Tc= 70°C	251(225) x 98 x 44.8
	EUD-320S220BT/BV/DT/DV	1540 ~ 2200	73 ~ 208	93.50%		
	EUD-320S320BT/BV/DT/DV	2240 ~ 3200	50 ~ 143	93.50%		
	EUD-320S460BT/BV/DT/DV	3220 ~ 4600	35 ~ 100	93.50%		
	EUD-320S670BT/BV/DT/DV	4690 ~ 6700	24 ~ 68	93.50%		
480	EUD-480S140DT/DV	1050 ~ 1400	171 ~ 457	95.00%	91,000 Tc= 70°C	262(235) x 125 x 43.5
	EUD-480S280DT/DV	2100 ~ 2800	86 ~ 228	94.00%		
	EUD-480S420DT/DV	3150 ~ 4200	57 ~ 152	94.50%		
	EUD-480S560DT/DV	4350 ~ 5600	43 ~ 110	94.00%		
	EUD-480S10ADT/DV	7500 ~ 10000	24 ~ 64	94.00%		
600	EUD-600S140DT/DV/BT/BV	1100 ~ 1400	214 ~ 545	94.50%	90,000 Tc= 70°C	275(250) x 144 x 48.5
	EUD-600S170DT/DV	1360 ~ 1700	176 ~ 441	94.00%		
	EUD-600S210DT/DV	1680 ~ 2100	143 ~ 357	94.50%		
	EUD-600S280BT/BV/DT/DV	2240 ~ 2800	108 ~ 268	95.00%		
	EUD-600S420BT/BV/DT/DV	3360 ~ 4200	72 ~ 178	94.50%		
	EUD-600S560BT/BV/DT/DV	4480 ~ 5600	54 ~ 134	94.50%		
	EUD-600S740BT/BV/DT/DV	5920 ~ 7400	41 ~ 101	94.00%		
	EUD-600S980BT/BV/DT/DV	7840 ~ 9800	31 ~ 76	94.00%		
EUD-600S12ADT/DV	10000 ~ 12500	24 ~ 60	94.00%			

★ : Class 2 Model



» Inventronics Advantages

- Innovative Design without Electrolytic Capacitors
- Full Power at Wide Output Current Range (Constant Power)
- Adjustable Output Current with Programability (Off-Line)
- Input Voltage Range: 90 ~ 305Vac
- Always-on Auxiliary Power: 12Vdc, 200mA
- Thermal Sensing and Protection for LED Module
- Output Lumen Compensation
- Input Surge Protection: DM 6kV, CM 10kV
- All-Around Protection: OVP, SCP, OTP
- IP67 and UL Dry / Damp / Wet Location
- Class 2 & SELV Output
- TYPE HL, for use in a Class I, Division 2 hazardous (Classified) location
- 10-Year Warranty

» About EUD-L

The EUD-DTL / DVL series consists of industry leading Controls-Ready, programmable LED drivers offer an ultra-long lifetime and are backed by a 10-year warranty. Their novel design eliminates electrolytic capacitors which is the key limitation in lifetime for traditional driver designs and incorporates other unique design features to provide a more robust driver for applications requiring an extremely long operation life. They provide a high level of flexibility with several models supplying 96W-240W power ranges, programmable output currents from 450-6700mA and multiple dimming options.

» Dimming Functions

- 0-10V / PWM / 3-Timer-Modes
- Dim-to-Off with Standby Power ≤ 0.5 W

» Safety Certifications



» Power Levels

96W 150W 240W

Output Power (W)	Model No.	Full-power Current Range(mA)	Output Voltage Range (Vdc)	Eff. @ 220Vac	Lifetime (hours)	Dimensions (L*W*H)(mm)
96	EUD-096S070DTL/DVL	450 ~ 700	74 ~ 213	92.50%	100,000 Tc= 85°C	201(180) × 67.5 × 36.5
	EUD-096S105DTL/DVL	700 ~ 1050	48 ~ 137	92.00%		
	EUD-096S210DTL/DVL	1400 ~ 2100	24 ~ 69	91.50%		
	EUD-096S215DTL ★	1750 ~ 2150	24 ~ 55	91.00%		
	EUD-096S350DTL/DVL ★	2450 ~ 3500	14 ~ 39	91.50%		
150	EUD-150S070DTL/DVL	450 ~ 700	117 ~ 333	93.00%	100,000 Tc= 85°C	209(188) × 67.5 × 39.7
	EUD-150S105DTL/DVL	700 ~ 1050	75 ~ 214	93.00%		
	EUD-150S210DTL/DVL	1400 ~ 2100	38 ~ 107	92.50%		
	EUD-150S350DTL/DVL	2450 ~ 3500	22 ~ 61	92.00%		
	EUD-150S560DTL/DVL	3850 ~ 5600	14 ~ 39	91.00%		
240	EUD-240S105DTL/DVL	700 ~ 1050	114 ~ 343	93.50%	100,000 Tc= 85°C	246(225) × 67.5 × 39.7
	EUD-240S210DTL/DVL	1400 ~ 2100	57 ~ 171	93.50%		
	EUD-240S420DTL/DVL	2800 ~ 4200	29 ~ 86	92.50%		
	EUD-240S670DTL/DVL	4450 ~ 6700	18 ~ 54	92.50%		

★ : Class 2 Model



» Inventronics Advantages

- Inventronics Patented Circular Metal Case
- High Efficiency (Up to 93.0%)
- Full Power at Wide Output Current Range (Constant Power)
- Input Voltage Range: 90 ~ 305Vac
- Input Surge Protection: DM 4kV, CM 4kV
- All-Around Protection: OVP, SCP, OTP
- IP65 and UL Dry / Damp / Wet Location
- Class 2 & SELV Output
- TYPE HL, for use in a Class I, Division 2 hazardous (Classified) location
- 5-Year Warranty

» Dimming Functions

- 0-10V / PWM (DT / DV Models)

» Safety Certifications



» Power Levels

96W 150W 200W 240W 320W

» About EUR

Inventronics EUR Series offer a unique, circular shape making them easier to install and provide a more sleek, streamlined appearance. They are available in packages accommodating rink or hook mounting and three different case colors to fit perfectly with any lighting fixture. The EUR Series is available in both dimming and non-dimming models with programmable or adjustable output currents and longer lifetimes.

» Accessories for EUR



Output Power (W)	Model No.	Full-power Current Range(mA)	Output Voltage Range (Vdc)	Eff. @ 220Vac	Lifetime (hours)	Dimensions (∅*H)(mm)
96	EUR-096S210DT/DV	1400 ~ 2100	24 ~ 69	91.50%	85,000 Tc= 70°C	∅130 x 70
	EUR-096S210ST/SV	1400 ~ 2100	24 ~ 69	91.50%		
	EUR-096S215DT ★	1750 ~ 2150	24 ~ 55	92.00%		
	EUR-096S350DT/DV ★	2450 ~ 3500	14 ~ 39	91.00%		
	EUR-096S350ST/SV ★	2450 ~ 3500	14 ~ 39	91.00%		
150	EUR-150S350DT/DV	2450 ~ 3500	22 ~ 61	92.50%	89,000 Tc= 70°C	∅150 x 72
	EUR-150S350ST/SV	2450 ~ 3500	22 ~ 61	92.50%		
	EUR-150S560DT/DV	3850 ~ 5600	14 ~ 39	91.50%		
	EUR-150S560ST/SV	3850 ~ 5600	14 ~ 39	91.50%		
200	EUR-200S350DT/DV	2450 ~ 3500	29 ~ 82	93.00%	82,000 Tc= 70°C	∅150 x 72
	EUR-200S350ST/SV	2450 ~ 3500	29 ~ 82	93.00%		
	EUR-200S560DT/DV	3850 ~ 5600	18 ~ 52	92.50%		
	EUR-200S560ST/SV	3850 ~ 5600	18 ~ 52	92.50%		
240	EUR-240S420DT/DV	2800 ~ 4200	29 ~ 86	93.00%	65,000 Tc= 70°C	∅190 x 79.6
	EUR-240S420ST/SV	2800 ~ 4200	29 ~ 86	93.00%		
	EUR-240S670DT/DV	4450 ~ 6700	18 ~ 54	92.50%		
	EUR-240S670ST/SV	4450 ~ 6700	18 ~ 54	92.50%		
320	EUR-320S460DT/DV	3220 ~ 4600	35 ~ 100	92.50%	75,000 Tc= 70°C	∅190 x 79.6
	EUR-320S460ST/SV	3220 ~ 4600	35 ~ 100	92.50%		
	EUR-320S670DT/DV	4690 ~ 6700	24 ~ 68	92.50%		
	EUR-320S670ST/SV	4690 ~ 6700	24 ~ 68	92.50%		

★ : Class 2 Model



» Inventronics Advantages

- Inventronics Patented Metal Case
- High Efficiency (Up to 93.5%)
- Full Power at Wide Output Current Range (Constant Power)
- Adjustable Output Current with Programability (Off-Line)
- Input Voltage Range: 90 ~ 305Vac
- Input Surge Protection: DM 4kV, CM 6kV
- All-Around Protection: OVP, SCP, OTP
- IP67 and UL Dry / Damp / Wet Location
- Class 2 & SELV Output
- TYPE HL, for use in a Class I, Division 2 hazardous (Classified) location
- 5-Year Warranty

» Dimming Functions

- Isolated 0-10V / 10V PWM

» Safety Certifications



» Power Levels

96W 150W 200W 240W

» About HUK

Inventronics HUK Series provide a vertical installation with a patented, reinforced rust-proof metal housing and an IP67 rating that stands up to caustic environments. They provide flexibility by offering multiple installation options, easy assembly and installation, isolated dimming options a wide range of programmable, constant-power output currents.

» Accessories for HUK



BRK-BTM01



BRK-BTM00



BLT-M1200



BRK-UPR01



BRK-UPR00



HKK-D1500

Output Power (W)	Model No.	Full-power Current Range(mA)	Output Voltage Range (Vdc)	Eff. @ 220Vac	Lifetime (hours)	Dimensions (L*W*H)(mm)
96	HUK-096S105DT/DV	700 ~ 1050	48 ~ 137	92.00%	108,000 Tc= 70°C	165 x 68 x 68
	HUK-096S210DT/DV	1400 ~ 2100	24 ~ 69	91.00%		
	HUK-096S350DT/DV ★	2450 ~ 3500	14 ~ 39	89.00%		
150	HUK-150S105DT/DV	700 ~ 1050	75 ~ 214	93.00%	77,000 Tc= 70°C	176 x 68 x 68
	HUK-150S350DT/DV	2450 ~ 3500	22 ~ 61	91.50%		
	HUK-150S560DT/DV	3850 ~ 5600	14 ~ 39	90.50%		
200	HUK-200S105DT/DV	700 ~ 1050	95 ~ 286	93.50%	87,000 Tc= 70°C	208 x 68x 68
	HUK-200S350DT/DV	2450 ~ 3500	29 ~ 82	93.00%		
	HUK-200S560DT/DV	3850 ~ 5600	18 ~ 52	92.00%		
240	HUK-240S105DT/DV	700 ~ 1050	114 ~ 343	93.50%	89,000 Tc= 70°C	218 x 68 x 68
	HUK-240S420DT/DV	2800 ~ 4200	29 ~ 86	92.50%		
	HUK-240S670DT/DV	4600 ~ 6700	18 ~ 52	92.00%		

★ : Class 2 Model



» Inventronics Advantages

- Ultra High Efficiency (Up to 93.5%)
- Constant-Voltage Output
- Input Voltage Range: 90 ~ 305Vac
- Input Surge Protection: DM 2kV / 4kV, CM 6kV
- All-Around Protection: OVP, SCP, OTP, OCP
- IP67 and UL Dry / Damp / Wet Location
- Class 2 & SELV Output
- TYPE HL, for use in a Class I, Division 2 hazardous (Classified) location
- 5-Year Warranty

» Dimming Functions

- Isolated 0-10V (DTA / DVA Models)

» Safety Certifications



SAA EAC 

» Power Levels

26W 76W 96W 150W 200W 250W 300W 600W

» About EUV

Inventronics EUV Series offers a broad portfolio of constant-voltage LED drivers providing flexibility with a wide-range of power and voltage levels. They provide extreme durability with an IP67 rating, encapsulated design for enhanced thermal conduction and protection against vibration, as well as a high level of built-in surge protection.

Output Power (W)	Model No.	Output Current Range (A)	Output Voltage (Vdc)	Eff. @ 220Vac	Lifetime (hours)	Dimensions (L*W*H)(mm)
26	EUV-026S024PS ★	0 ~ 1.08	24	84.00%	91,100 Tc= 60°C	78 x 80 x 27
	EUV-026S036PS ★	0 ~ 0.72	36	85.00%		
	EUV-026S048PS ★	0 ~ 0.54	48	86.00%		
76	EUV-076S012ST/SV ★	0 ~ 5.00	12	87.00%	51,000 Tc= 65°C	177(150) x 67.5 x 36.5
	EUV-076S024ST/SV ★	0 ~ 3.17	24	88.00%		
	EUV-076S036ST/SV ★	0 ~ 2.11	36	89.00%		
	EUV-076S042ST/SV ★	0 ~ 1.81	42	89.00%		
	EUV-076S048ST/SV ★	0 ~ 1.58	48	89.00%		
	EUV-076S054ST/SV ★	0 ~ 1.41	54	90.00%		
96	EUV-096S024ST/SV ★	0 ~ 4.00	24	87.00%	56,600 Tc= 60°C	201(174)x 67.5 x 36.5
	EUV-096S036ST/SV ★	0 ~ 2.66	36	88.00%		
	EUV-096S048ST/SV ★	0 ~ 2.00	48	88.00%		
	EUV-096S054ST/SV ★	0 ~ 1.77	54	90.00%		
150	EUV-150S012ST/SV	0 ~ 12.50	12	92.00%	77,200 Tc= 60°C	226(199) x 67.5 x 39.5
	EUV-150S024ST/SV	0 ~ 6.25	24	93.00%		
	EUV-150S036ST/SV	0 ~ 4.17	36	93.00%		
	EUV-150S042ST/SV	0 ~ 3.57	42	93.00%		
	EUV-150S048ST/SV	0 ~ 3.13	48	93.00%	89,000 Tc= 70°C	201(180) x 67.5 x 36.5
	EUV-150S054ST/SV	0 ~ 2.78	54	93.00%		
	EUV-150S012STA/SVA/DTA/DVA	0 ~ 12.50	12	90.00%		
	EUV-150S024STA/SVA/DTA/DVA	0 ~ 6.25	24	90.50%		
200	EUV-200S012ST/SV	0 ~ 15.00	12	91.00%	95,200 Tc= 60°C	226(199) x 67.5 x 39.5
	EUV-200S024ST/SV	0 ~ 8.33	24	92.00%		
	EUV-200S036ST/SV	0 ~ 5.56	36	92.00%		
	EUV-200S042ST/SV	0 ~ 4.76	42	92.50%		
	EUV-200S048ST/SV	0 ~ 4.17	48	92.50%		
	EUV-200S054ST/SV	0 ~ 3.70	54	92.50%		
250	EUV-250S012ST/SV	0 ~ 18.33	12	91.50%	59,400 Tc= 60°C	251(224) x 90 x 37
	EUV-250S024ST/SV	0 ~ 10.41	24	92.00%		
	EUV-250S028ST/SV	0 ~ 8.93	28	92.00%		
	EUV-250S036ST/SV	0 ~ 6.94	36	92.50%		
	EUV-250S042ST/SV	0 ~ 5.95	42	92.50%		
	EUV-250S048ST/SV	0 ~ 5.20	48	93.00%		
	EUV-250S054ST/SV	0 ~ 4.62	54	93.50%		
300	EUV-300S012ST/SV	0 ~ 22.90	12	91.50%	58,000 Tc= 60°C	251(224) x 98 x 44.5
	EUV-300S024ST/SV	0 ~ 12.50	24	91.00%		
	EUV-300S028ST/SV	0 ~ 10.71	28	91.50%		
	EUV-300S036ST/SV	0 ~ 8.33	36	92.00%		
	EUV-300S042ST/SV	0 ~ 7.14	42	92.00%		
	EUV-300S048ST/SV	0 ~ 6.25	48	92.50%		
	EUV-300S054ST/SV	0 ~ 5.56	54	93.00%		
600	EUV-600S048SV	0 ~ 12.50	48	92.50%	106,000 Tc= 70°C	275(250) x 144 x 48.5
	EUV-600S054SV	0 ~ 11.20	54	93.00%		

★ : Class 2 Model



» Inventronics Advantages

- Ultra High Efficiency (Up to 92.5%)
- Full Power at Wide Output Current Range (Constant Power)
- Adjustable Output Current with NFC (Off-Line)
- Input Voltage Range: 90 ~ 305Vac
- Flicker-Free
- Input Surge Protection: DM 2kV / 6kV, CM 2kV / 6kV
- IP54 and UL Dry & Damp Location
- Suitable for Class I Luminaires
- Class 2 & SELV Output
- UL Class P Type
- 5-Year Warranty

» Dimming Functions

- Isolated 0-10V (DT Models)

» About LUN

Inventronics LUN series introduces wireless programming for an easier installation process without utilizing connection leads and a wide range of constant-power output currents. They provide even more design flexibility with models offering flicker-free isolated 0-10V dimming down to 5% and UL Class P models. The LUN series are IP54 rated and deliver built-in surge protection and long lifetimes.

» Safety Certifications



» Power Levels

42W 95W

Output Power (W)	Model No.	Full-power Current Range(mA)	Output Voltage Range (Vdc)	Eff. @ 220Vac	Lifetime (hours)	Dimensions (L*W*H)(mm)
42	LUN-042S105DT/ST ★	780 ~ 1050	20 ~ 54	88.00%	75,000 Tc= 70°C	95 x 70 x 32
	LUN-042S150DT/ST ★	1050 ~ 1500	14 ~ 40	87.00%		
95	LUN-095S105DT/ST	700 ~ 1050	46 ~ 137	92.50%	100,000 Tc= 70°C	240(212) x 43.5 x 32
	LUN-095S150DT/ST	1050 ~ 1500	32 ~ 91	92.00%		
	LUN-095S280DT/ST ★	1750 ~ 2800	17 ~ 54	91.50%		

★ : Class 2 Model



» Inventronics Advantages

- High Efficiency (Up to 88.5%)
- Full Power at Wide Output Current Range (Constant Power)
- Adjustable Output Current with Programability (Off-Line)
- Input Voltage Range: 90 ~ 305Vac
- Flicker-Free
- Tight Tolerance at Low Dimming Levels
- Suitable for Class I and Class II Luminaires
- Suitable for Built-in Use
- Class 2 & SELV Output
- UL Class P Type
- 5-Year Warranty

» Dimming Functions

- Isolated 0-10V

» About LUG

Inventronics LUG Series is IP20 rated and offers OEMs complete driver flexibility with constant-power at almost any output current range. They provide a tight tolerance in the low dimming range and flicker-free dimming to 10% giving it a consistent light quality performance. Their compact form factor and color-coded terminals facilitates safe and easy installation and provided the added convenience of UL Class P.

» Safety Certifications



» Power Levels

25W 40W

Output Power (W)	Model No.	Full-power Current Range(mA)	Output Voltage Range (Vdc)	Eff. @ 220Vac	Lifetime (hours)	Dimensions (L*W*H)(mm)
25	LUG-025S105DTE ★	500 ~ 1050	12 ~ 50	87.0%	85,000 Tc= 70°C	125.5 × 56 × 25
40	LUG-040S105DTE ★	800 ~ 1050	19 ~ 50	88.5%	64,000 Tc= 70°C	125.5 × 61 × 32
	LUG-040S150DTE ★	1050 ~ 1500	13 ~ 38	87.5%		

★ : Class 2 Model



» Inventronics Advantages

- Ultra High Efficiency (Up to 90.5%)
- Full Power at Wide Output Current Range (Constant Power)
- Adjustable Output Current with Programability (Off-Line)
- Input Voltage Range: 90 ~ 305Vac
- Always-on Auxiliary Power: 12Vdc, 200mA
- Flicker-Free
- Thermal Sensing and Protection for LED Module
- Output Lumen Compensation
- Class II, Class 2 & SELV Output
- Suitable for Built-in Use
- Class P, UL Listed Versions Available
- 5-Year Warranty

» Dimming Functions

- 0-10V / PWM / 3-Timer-Modes (DSF / DS2 Models)
- DALI / Push Dim (BSF / BS2 Models)
- Dim-to-off with Standby Power ≤ 0.5 W

» Safety Certifications



» Power Levels

40W 60W

» About LUD

Inventronics LUD Series is Controls-Ready and ideal for operation with a wide variety of sensors and controls. They provide customizable, constant-power output currents, multiple dimming options that are dimmable to 5% and low ripple for a flicker-free performance. They are IP20 rated and their slim, metal housing can fit in a multitude of luminaires giving OEMs the flexibility they need in their fixture design.

Output Power (W)	Model No.	Full-power Current Range(mA)	Output Voltage Range (Vdc)	Eff. @ 220Vac	Lifetime (hours)	Dimensions (L*W*H)(mm)
40	LUD-040S075BSF	350 ~ 750	17 ~ 114	90.00%	95,000 Tc= 60°C	360 x 30 x 21
	LUD-040S150BSF ★	750 ~ 1500	8 ~ 54	89.50%		
	LUD-040S075DSF	350 ~ 750	17 ~ 114	88.00%	96,000 Tc= 60°C	333 x 30 x 21
	LUD-040S150DSF ★	750 ~ 1500	8 ~ 54	88.00%		
60	LUD-060S055BS2	385 ~ 550	31 ~ 156	90.00%	107,000 Tc= 60°C	378 x 30 x 21
	LUD-060S078BS2	546 ~ 780	22 ~ 110	90.00%		
	LUD-060S110BS2	770 ~ 1100	16 ~ 78	90.00%		
	LUD-060S150BS2 ★	1050 ~ 1500	12 ~ 57	89.00%		
	LUD-060S210BS2 ★	1470 ~ 2100	8 ~ 40	89.00%		
	LUD-060S055DS2	385 ~ 550	31 ~ 156	90.50%	69,000 Tc= 70°C	
	LUD-060S078DS2	546 ~ 780	22 ~ 110	90.50%		
	LUD-060S110DS2	770 ~ 1100	16 ~ 78	90.50%		
	LUD-060S150DS2 ★	1050 ~ 1500	12 ~ 57	89.50%		
	LUD-060S210DS2 ★	1470 ~ 2100	8 ~ 40	88.00%		

★ : Class 2 Model



» Inventronics Advantages

- High Efficiency (Up to 92.0%)
- Full Power at Wide Output Current Range (Constant Power)
- Adjustable Output Current with Potentiometer
- Input Voltage Range: 90 ~ 305Vac
- Input Over Voltage Protection at 440Vac with 48 Hours
- Input Surge Protection: DM 4kV, CM 6kV
- All-Around Protection: IOVP, OVP, SCP, OTP
- IP67
- 5-Year Warranty

» About EAM

Inventronics New EAM series leverages many of the next generation platform enhancements we introduced in our EUM series but with an advanced circuitry design making it ideal for those markets who face challenging power regulations. This series offers an adjustable output current that provides constant power over a wide range of output currents. For additional protection they are equipped with an added 440Vac input over voltage protection feature and industry-leading surge protection.

» Safety Certifications



» Power Levels

150W

Output Power (W)	Model No.	Full-power Current Range(mA)	Output Voltage Range (Vdc)	Eff. @ 220Vac	Lifetime (hours)	Dimensions (L*W*H)(mm)
150	EAM-150S105SB	700 ~ 1050	72 ~ 214	92.00%	100,000 Tc= 70°C	178(161) x 60 x 34



EDC

» Inventronics Advantages

- Ultra High Efficiency (Up to 92.0%)
- Low THD, 10% Max up to 240 Vac
- Constant-Current Output
- Input Voltage Range: 140 ~ 305Vac
- Input Over Voltage Protection at 440Vac with 48 Hours
- Input UVP and Input OVP
- Input Surge Protection: DM 4kV, CM 6kV
- All-Around Protection: OVP, SCP, OTP
- IP66 / IP67
- 5-Year Warranty

» About EDC

Inventronics EDC series is designed specifically for those markets who face challenging power regulations. They help protect against poor quality supplied to the LED driver, reducing maintenance costs and safeguarding the luminaire. The EDC series offers a high level of marketing-leading input protection capable of handling frequent power outages or operating from a backup generator while providing a reliable, cost-effective solution.

» Safety Certifications



» Power Levels

75W 100W 150W

Output Power (W)	Model No.	Output Current (mA)	Output Voltage Range (Vdc)	Eff. @ 220Vac	Lifetime (hours)	Dimensions (L*W*H)(mm)
75	EDC-075S105ST/SV-0007	700	54 ~ 107	90.50%	101,000 Tc=75°C	131(114) × 64 × 32
	EDC-075S105ST/SV-0004	860	44 ~ 88	90.50%		
	EDC-075S105ST/SV	1050	36 ~ 71	90.00%		
100	EDC-100S105ST/SV-0007	700	71 ~ 143	91.00%	96,000 Tc=70°C	166(145) × 67.5 × 36.5
	EDC-100S105ST/SV-0004	860	58 ~ 116	90.50%		
	EDC-100S105ST/SV	1050	47 ~ 95	90.00%		
150	EDC-150S105ST/SV-0007	700	107 ~ 214	92.00%	97,000 Tc=70°C	187(166) × 67.5 × 39.7
	EDC-150S105ST/SV-0004	860	97 ~ 174	92.00%		
	EDC-150S105ST/SV	1050	97 ~ 143	91.00%		



» Inventronics Advantages

- Ultra High Efficiency (Up to 91.0%)
- Full Power at Wide Output Current Range (Constant Power)
- Thermal Sensing and Protection for LED Module
- Input Voltage Range: 176 ~ 305Vac
- Always-on Auxiliary Power: 12Vdc, 200mA
- Flicker-Free
- 5-Year Warranty

» Dimming Functions

- DALI / Push Dim
- Dim-to-Off with Standby Power ≤ 0.5 W

» Safety Certifications



» Power Levels

75W

» About LBD

Inventronics LBD Series are optimized for regions accepting a more narrow input voltage range of 176-305Vac. They are extremely flexible with programmable, constant-power output currents with flicker-free DALI dimming to 5%. The LBD Series is Controls-Ready offering even greater energy savings and provide thermal sensing protection for the LED module.

Output Power (W)	Model No.	Full-power Current Range(mA)	Output Voltage Range (Vdc)	Eff. @ 220Vac	Lifetime (hours)	Dimensions (L*W*H)(mm)
75	LBD-075S100BSF	700 ~ 1000	21 ~ 107	91.00%	89,000 Tc= 70°C	378 x 30 x 21
	LBD-075S150BSF	1050 ~ 1500	14 ~ 71	90.00%		
	LBD-075S210BSF	1470 ~ 2100	10 ~ 51	89.50%		



EBV

» Inventronics Advantages

- Ultra High Efficiency (Up to 94.5%)
- Constant-Voltage Output
- Input Voltage Range: 176 ~ 305Vac
- Input Surge Protection: DM 4kV, CM 6kV
- All-Around Protection: OVP, SCP, OTP, OCP
- IP67 and UL Dry / Damp / Wet Location
- SELV Output
- TYPE HL, for use in a Class I, Division 2 hazardous (Classified) location
- 5-Year Warranty

» About EBV

Inventronics narrow input voltage drivers provide a wide range of power levels. The EBV series is made with a compact, extruded-metal housing enabling more creative freedom on luminaire design. The EBV series is IP67 rated and ideal for challenging applications such as architectural, decorative, signage.

» Safety Certifications



» Power Levels

60W 75W 100W 150W 200W 250W 350W 400W 500W

Output Power (W)	Model No.	Output Current Range (A)	Output Voltage (Vdc)	Eff. @ 220Vac	Lifetime (hours)	Dimensions (L*W*H)(mm)
60	EBV-060S012SV	0 ~ 5.00	12	84.50%	96,000 Tc= 70°C	116(95) × 67.5 × 36.5
	EBV-060S024SV	0 ~ 2.50	24	88.50%		
	EBV-060S036SV	0 ~ 1.70	36	89.50%		
	EBV-060S048SV	0 ~ 1.30	48	90.50%		
75	EBV-075S024SV	0 ~ 3.20	24	88.00%	97,000 Tc= 70°C	116(95) × 67.5 × 36.5
	EBV-075S036SV	0 ~ 2.10	36	89.00%		
	EBV-075S048SV	0 ~ 1.60	48	90.00%		
100	EBV-100S012SV	0 ~ 8.40	12	85.50%	85,000 Tc= 70°C	166(145) × 67.5 × 36.5
	EBV-100S024SV	0 ~ 4.20	24	90.00%		
	EBV-100S036SV	0 ~ 2.80	36	91.50%		
	EBV-100S048SV	0 ~ 2.10	48	92.00%		
150	EBV-150S012SV	0 ~ 10.00	12	85.50%	83,000 Tc= 70°C	166(145) × 67.5 × 39.7
	EBV-150S024SV	0 ~ 6.30	24	88.50%		
	EBV-150S036SV	0 ~ 4.20	36	91.50%		
	EBV-150S048SV	0 ~ 3.20	48	91.50%		
200	EBV-200S012SV	0 ~ 16.70	12	91.50%	106,000 Tc= 70°C	190(169) × 67.5 × 39.7
	EBV-200S024SV	0 ~ 8.40	24	93.00%		
	EBV-200S036SV	0 ~ 5.60	36	92.50%		
	EBV-200S048SV	0 ~ 4.20	48	93.50%		
250	EBV-250S012SV	0 ~ 18.40	12	91.50%	96,000 Tc= 70°C	190(169) × 67.5 × 39.7
	EBV-250S024SV	0 ~ 10.50	24	93.00%		
	EBV-250S036SV	0 ~ 7.00	36	92.50%		
	EBV-250S048SV	0 ~ 5.30	48	93.50%		
350	EBV-350S012SV	0 ~ 25.00	12	91.50%	114,000 Tc= 70°C	227(200) × 80 × 42
	EBV-350S024SV	0 ~ 14.60	24	93.50%		
	EBV-350S036SV	0 ~ 9.80	36	93.50%		
	EBV-350S048SV	0 ~ 7.30	48	93.00%		
400	EBV-400S012SV	0 ~ 28.40	12	91.00%	97,000 Tc= 70°C	227(200) × 80 × 42
	EBV-400S024SV	0 ~ 16.70	24	93.00%		
	EBV-400S036SV	0 ~ 11.20	36	93.00%		
	EBV-400S048SV	0 ~ 8.40	48	92.50%		
500	EBV-500S024ST/SV	0 ~ 20.83	24	93.50%	117,000 Tc= 60°C	291(264) × 108 × 45.5
	EBV-500S028ST/SV	0 ~ 17.85	28	93.50%		
	EBV-500S036ST/SV	0 ~ 13.88	36	94.00%		
	EBV-500S042ST/SV	0 ~ 11.90	42	94.50%		
	EBV-500S048ST/SV	0 ~ 10.41	48	94.50%		



» **Inventronics Advantages**

- Ultra High Efficiency (Up to 91.5%)
- Constant-Voltage Output
- Input Voltage Range: 176 ~ 305Vac
- Input Surge Protection: DM 4kV, CM 6kV
- All-Around Protection: OVP, SCP, OTP, OCP
- IP67
- SELV Output
- 5-Year Warranty

» **Safety Certifications**



» **Power Levels**

36W 48W 60W 72W

» **About EBV-F**

Inventronics EBV series optimizes the input voltage range allowing for reduced manufacturing costs for regions that accept a narrow range. These compact drivers are equipped with extruded-metal housing, IP67 rated and provide a higher level of input surge protection. They are ideal in architectural, decorative and signage lighting applications.

Output Power (W)	Model No.	Output Current Range (A)	Output Voltage (Vdc)	Eff. @ 220Vac	Lifetime (hours)	Dimensions (L*W*H)(mm)
36	EBV-036S024SVF	0 ~ 1.50	24	86.00%	104,000 Tc= 70°C	155(134) x 40 x 25
	EBV-036S036SVF	0 ~ 1.00	36	86.50%		
	EBV-036S048SVF	0 ~ 0.75	48	87.00%		
48	EBV-048S024SVF	0 ~ 2.00	24	85.00%	104,000 Tc= 70°C	155(134) x 40 x 25
	EBV-048S036SVF	0 ~ 1.34	36	86.50%		
	EBV-048S048SVF	0 ~ 1.00	48	88.00%		
60	EBV-060S024SVF	0 ~ 2.50	24	88.50%	99,000 Tc= 70°C	185(164) x 40 x 25
	EBV-060S036SVF	0 ~ 1.70	36	89.50%		
	EBV-060S048SVF	0 ~ 1.25	48	91.50%		
72	EBV-072S024SVF	0 ~ 3.00	24	88.50%	99,000 Tc= 70°C	185(164) x 40 x 25
	EBV-072S036SVF	0 ~ 2.00	36	89.50%		
	EBV-072S048SVF	0 ~ 1.50	48	91.00%		

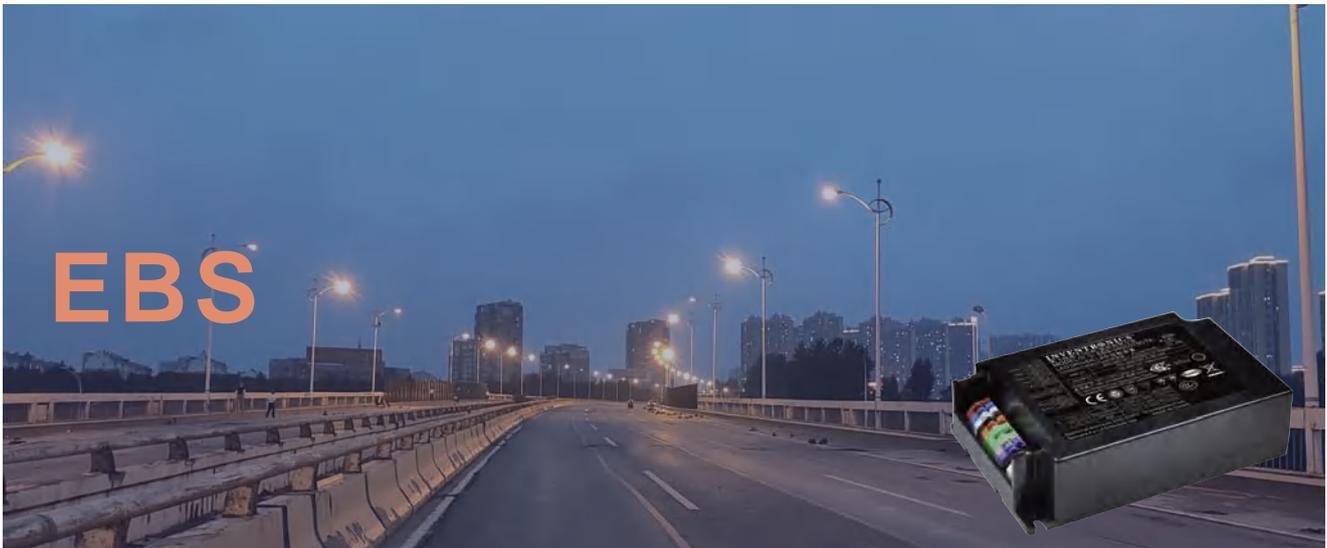

» Inventronics Advantages

- Ultra High Efficiency (Up to 94.0%)
- Full Power at Wide Output Current Range (Constant Power)
- Adjustable Output Current with Programmability (Off-Line)
- Thermal Sensing and Protection for LED Module
- Input Voltage Range: 176 ~ 305Vac
- Always-on Auxiliary Power: 12Vdc, 200mA (Transient Peak Current up to 400mA)
- Output Lumen Compensation
- Input Surge Protection: DM 6kV, CM 10kV
- All-Around Protection: OVP, SCP, OTP
- IP20 Design and Suitable for Some Outdoor Applications in Luminaires with IP > 54
- SELV Output
- Suitable for Luminaires with Protection Class I and II
- Complies with Zhaga Interface Specification Book 13
- 7-Year Warranty

» Dimming Functions

- 0-10V / PWM / 3-Timer-Modes (DTE Models)
- DALI / AC Dim / 3-Timer-Modes (BTE Models)
- Dim-to-Off with Standby Power \leq 0.5 W

» Power Levels

- 40W 80W 120W 160W

» Safety Certifications



» About EBS

Inventronics Class I / II, Controls-Ready programmable EBS family utilizes push terminals to provide flexibility and easier installation while reducing production and installation costs. The Zhaga compatible design is optimal for the more compact, slimmer European street luminaires and the IP20 rating makes them suitable for outdoor applications in luminaires with IP > 54. They can also be upgraded to become an 'independent' LED driver for mounting outside a luminaire enclosure.

» Accessories



END-CAP01

Cable Clamp for Independent Applications

Output Power (W)	Model No.	Full-power Current Range(mA)	Output Voltage Range (Vdc)	Eff. @ 220Vac	Lifetime (hours)	Dimensions (L*W*H)(mm)
40	EBS-040S070DTE	450 ~ 700	28 ~ 89	90.00%	93,000 Tc= 75°C	123 x 79 x 33
	EBS-040S105DTE	700 ~ 1050	19 ~ 57	90.00%		
	EBS-040S070BTE	450 ~ 700	28 ~ 89	89.50%		
	EBS-040S105BTE	700 ~ 1050	19 ~ 57	89.50%		
80	EBS-080S070DTE	450 ~ 700	57 ~ 178	93.00%	120,000 Tc= 75°C	125 x 85 x 36
	EBS-080S105DTE	700 ~ 1050	38 ~ 114	92.50%		
	EBS-080S070BTE	450 ~ 700	57 ~ 178	93.00%		
	EBS-080S105BTE	700 ~ 1050	38 ~ 114	92.50%		
120	EBS-120S070DTE	500 ~ 700	86 ~ 240	93.50%	120,000 Tc= 75°C	165 x 70 x 39.5
	EBS-120S105DTE	700 ~ 1050	57 ~ 171	93.50%		
	EBS-120S150DTE	1050 ~ 1500	40 ~ 114	93.50%		
	EBS-120S070BTE	500 ~ 700	86 ~ 240	93.50%		
	EBS-120S105BTE	700 ~ 1050	57 ~ 171	93.50%		
	EBS-120S150BTE	1050 ~ 1500	40 ~ 114	93.50%		
160	EBS-160S070DTE	450 ~ 700	115 ~ 356	93.50%	102,000 Tc= 75°C	170 x 100 x 40
	EBS-160S105DTE	700 ~ 1050	76 ~ 229	94.00%		
	EBS-160S070BTE	450 ~ 700	115 ~ 356	94.00%		
	EBS-160S105BTE	700 ~ 1050	76 ~ 229	94.00%		



» Inventronics Advantages

- Ultra High Efficiency (Up to 95.0%)
- Full Power at Wide Output Current Range (Constant Power)
- Adjustable Output Current with External Resistor (Off-Line)
- Input Voltage Range: 198 ~ 264Vac
- Flicker-Free
- Input Surge Protection: DM 1kV / 2kV, CM 2kV / 4kV
- Suitable for Luminaires with Protection Class I
- Complies with Zhaga Interface Specification Book 13
- Non-Isolated Design
- 5-Year Warranty

» Safety Certifications



» Power Levels

80W 160W

» About LMT

Inventronics LMT series are IP20 Rated and non-isolated making them ideal for built-in indoor projects. They provide a higher efficiency due to a more efficient circuit design than typical drivers. The LMT series offers complete driver flexibility with an adjustable output current via an external resistor, flicker-free performance, low output current ripple and a more compact Zhaga Book 13 compliant form factor.

Output Power (W)	Model No.	Full-power Current Range(mA)	Output Voltage Range (Vdc)	Eff. @ 220Vac	Lifetime (hours)	Dimensions (L*W*H)(mm)
80	LMT-080S050STF	350 ~ 500	96 ~ 229	94.00%	89,000 Tc= 70°C	280 x 30 x 21
	LMT-080S070STF	500 ~ 700	68 ~ 160	94.00%		
	LMT-080S105STF	700 ~ 1050	45 ~ 114	93.00%		
160	LMT-160S070STF	500 ~ 700	137 ~ 320	95.00%	109,000 Tc= 70°C	360 x 30 x 21
	LMT-160S105STF	700 ~ 1050	91 ~ 229	94.50%		
	LMT-160S150STF	1050 ~ 1500	64 ~ 153	94.50%		



» Inventronics Advantages

- Ultra High Efficiency (Up to 96.5%)
- Full Power at Wide Output Current Range (Constant Power)
- Adjustable Output Current with External Resistor (Off-Line)
- Input Voltage Range: 342 ~ 457Vac
- Flicker-Free
- Input Surge Protection: DM 2kV, CM 4kV
- Suitable for Luminaires with Protection Class I
- Non-Isolated Design
- 5-Year Warranty

» About LNT

Inventronics LNT series are IP20 Rated and non-isolated making them ideal for built-in indoor projects. They provide a much higher efficiency due to a more efficient circuit design than typical drivers. The LNT series offers complete driver flexibility with an adjustable output current via an external resistor, flicker-free performance, added input surge protection and long lifetimes. They are ideal for industrial and horticulture lighting applications.

» Safety Certifications



» Power Levels

350W

Output Power (W)	Model No.	Full-power Current Range(mA)	Output Voltage Range (Vdc)	Eff. @ 400Vac	Lifetime (hours)	Dimensions (L*W*H)(mm)
350	LNT-350S150STF	1050 ~ 1500	140 ~ 333	96.50%	100,000 Tc= 70°C	425 x 40 x 30



» Inventronics Advantages

- Ultra High Efficiency (Up to 96.0%)
- Full Power at Wide Output Current Range (Constant Power)
- Adjustable Output Current with External Resistor(Off-Line)
- Thermal Sensing and Protection for LED Module
- Input Voltage Range: 180 ~ 528Vac
- Always-on Auxiliary Power: 12Vdc, 200mA
- Output Lumen Compensation
- Input Surge Protection: DM 6kV, CM 10kV
- All-Around Protection: OVP, SCP, OTP
- IP67 and UL Wet / Dry / Damp Location
- TYPE HL, for use in a Class I, Division 2 hazardous (Classified) location
- 5-Year Warranty

» Dimming Functions

- Isolated 0-10V / PWM / 3-Timer-Modes
- Dim-to-Off with Standby Power \leq 2.5W

» Safety Certifications



» About EFD

Inventronics EFD series supplies 1200W and operates at a wider input voltage range for single and three phase applications. They are designed to address and industry gap in high-powered applications and eliminate the need for multiple drivers. They are Controls-Ready and help to simplify luminaire design, reduce costs, provide an easier thermal management and stress-free installation.

» Power Levels

1200W

Output Power (W)	Model No.	Full-power Current Range(mA)	Output Voltage Range (Vdc)	Eff. @ 480Vac	Lifetime (hours)	Dimensions (L*W*H)(mm)
1200	EFD-1K2S420DT/DV	3360-4200	143-357	96.00%	100,000 Tc= 70°C	280 x 230(175) x 76
	EFD-1K2S560DT/DV	4480-5600	108-268	95.50%		
	EFD-1K2S740DT/DV	5920-7400	81-202	95.00%		



» Inventronics Advantages

- Ultra High Efficiency (Up to 94.5%)
- Ultra High Input Voltage
- Constant Voltage Output
- Input Voltage Range: 249 ~ 528Vac
- Input Surge Protection: DM 4kV, CM 6kV
- All-Around Protection: OTP, OVP, SCP and Open Lamp
- IP67 and UL Dry / Damp and Wet Location
- TYPE HL, for use in a Class I, Division 2 hazardous (Classified) location
- 5-Year Warranty

» About ESV

Inventronics ESV Series provides high input voltage, constant-voltage models that are rugged, reliable and a great option for lighting in challenging applications. They offer industry-leading surge protection, long lifetimes and an IP67 rating. The ESV series also delivers a convenient, reliable dc voltage to the project' s circuitry and provide the bus voltage in a distributed architecture application.

» Safety Certifications



» Power Levels

150W 300W 320W 600W

Output Power (W)	Model No.	Output Current Range (A)	Output Voltage (Vdc)	Eff. @ 480Vac	Lifetime (hours)	Dimensions (L*W*H)(mm)
150	ESV-150S012ST	0 ~ 10.00	12	91.50%	104,000 Tc= 70°C	242(221) × 67.5 × 39.7
	ESV-150S024ST	0 ~ 6.25	24	93.00%		
	ESV-150S036ST	0 ~ 4.17	36	94.50%		
	ESV-150S042ST	0 ~ 3.57	42	93.50%		
	ESV-150S048ST	0 ~ 3.13	48	94.00%		
300	ESV-300S024ST	0 ~ 12.50	24	89.00%	79,000 Tc= 70°C	251(224) × 93.9 × 43.5
	ESV-300S028ST	0 ~ 10.70	28	90.00%		
	ESV-300S036ST	0 ~ 8.33	36	90.00%		
	ESV-300S042ST	0 ~ 7.14	42	90.00%		
	ESV-300S048ST	0 ~ 6.25	48	90.00%		
320	ESV-320S024ST/SV	0 ~ 13.40	24	92.50%	93,000 Tc= 70°C	251(224) × 98 × 44.8
	ESV-320S036ST/SV	0 ~ 8.90	36	92.50%		
	ESV-320S048ST/SV	0 ~ 6.70	48	93.00%		
	ESV-320S054ST/SV	0 ~ 6.00	54	93.50%		
600	ESV-600S048ST/SV	0 ~ 12.50	48	93.00%	117,000 Tc= 70°C	276(250) × 144 × 48.5
	ESV-600S054ST/SV	0 ~ 11.20	54	93.50%		



» Inventronics Advantages

- Ultra High Efficiency (Up to 95.0%)
- Full Power at Wide Output Current Range (Constant Power)
- Adjustable Output Current with Programability (Off-Line)
- Thermal Sensing and Protection for LED Module
- Input Voltage Range: 249 ~ 528Vac
- Always-on Auxiliary Power: 12Vdc, 200mA
- Output Lumen Compensation
- Input Surge Protection: DM 4kV / 6kV, CM 6kV / 10kV
- All-Around Protection: OVP, SCP, OTP
- IP67 and UL Dry / Damp / Wet Location
- TYPE HL, for use in a Class I, Division 2 hazardous (Classified) location
- 5-Year Warranty

» Dimming Functions

- 0-10V / PWM / 3-Timer-Modes
- Dim-to-Off with Standby Power \leq 1.5W

» Safety Certifications



» Power Levels

96W 150W 240W 320W 480W 600W

» About ESD

Inventronics high input voltage, programmable ESD family comprises the broadest portfolio of high power LED drivers in the industry that operate from 277Vac to 480Vac. These Controls-Ready drivers offer multiple dimming capabilities and programmability providing more project flexibility, better energy savings and more convenience.

Output Power (W)	Model No.	Full-power Current Range(mA)	Output Voltage Range (Vdc)	Eff.@ 480Vac	Lifetime (hours)	Dimensions (L*W*H)(mm)
96	ESD-096S090DT	450 ~ 900	64 ~ 214	90.50%	108,000 Tc= 70°C	239(212) × 67.5 × 36.5
	ESD-096S180DT	900 ~ 1800	32 ~ 107	90.50%		
	ESD-096S360DT ★	1800 ~ 3600	16 ~ 53	89.50%		
150	ESD-150S105DT	700 ~ 1050	75 ~ 214	94.50%	99,000 Tc= 70°C	242(221) × 67.5 × 39.7
	ESD-150S210DT	1400 ~ 2100	38 ~ 107	94.00%		
	ESD-150S350DT	2450 ~ 3500	22 ~ 61	93.00%		
	ESD-150S560DT	3850 ~ 5600	14 ~ 39	93.00%		
240	ESD-240S100DT	700 ~ 1000	120 ~ 343	94.00%	114,000 Tc= 70°C	262(241) × 67.5 × 39.7
	ESD-240S150DT	1050 ~ 1500	80 ~ 229	93.50%		
	ESD-240S220DT	1540 ~ 2200	55 ~ 156	93.00%		
	ESD-240S320DT	2240 ~ 3200	38 ~ 107	93.00%		
	ESD-240S460DT	3220 ~ 4600	27 ~ 75	93.00%		
	ESD-240S660DT	4620 ~ 6600	19 ~ 52	92.50%		
320	ESD-320S150DT	1050 ~ 1500	107 ~ 305	94.00%	120,000 Tc= 70°C	261(234) × 98 × 44.8
	ESD-320S220DT	1540 ~ 2200	73 ~ 208	94.50%		
	ESD-320S310DT	2170 ~ 3100	52 ~ 148	94.00%		
	ESD-320S440DT	3080 ~ 4400	37 ~ 104	94.00%		
	ESD-320S620DT	4340 ~ 6200	26 ~ 74	93.50%		
480	ESD-480S140DT/DV	1050 ~ 1400	171 ~ 457	95.00%	102,000 Tc= 70°C	262(235) × 125 × 43.5
	ESD-480S280DT/DV	2100 ~ 2800	86 ~ 228	94.50%		
	ESD-480S420DT/DV	3150 ~ 4200	57 ~ 152	94.00%		
	ESD-480S560DT/DV	4350 ~ 5600	43 ~ 110	93.50%		
	ESD-480S10ADT/DV	7500 ~ 10000	24 ~ 64	93.50%		
600	ESD-600S170DT/DV	1360 ~ 1700	176 ~ 441	95.00%	101,000 Tc= 70°C	276(250) × 144 × 48.5
	ESD-600S210DT/DV	1680 ~ 2100	143 ~ 357	95.00%		
	ESD-600S280DT/DV	2240 ~ 2800	108 ~ 268	94.50%		
	ESD-600S420DT/DV	3360 ~ 4200	72 ~ 178	95.00%		
	ESD-600S560DT/DV	4480 ~ 5600	54 ~ 134	95.00%		
	ESD-600S740DT/DV	5920 ~ 7400	41 ~ 101	94.50%		
	ESD-600S980DT/DV	7840 ~ 9800	31 ~ 76	94.00%		
	ESD-600S12ADT/DV	10000 ~ 12500	24 ~ 60	94.00%		

★ : Class 2 Model



CONTROLS-READY

Driver Health Monitoring and Smart Lighting Solutions

» Driver Health Monitoring

- Inventronics Digital Dimming is available on select Controls-Ready drivers
- Allows critical information to be analyzed by a control system to extend driver life
- Available Information:
 - Internal and External Temperature
 - Read Output Current and Voltage
 - Dim Driver
 - Read Driver Model Number
 - Program Output Current

» Controls-Ready Drivers

- Offer ease of controls integration
 - Auxiliary supply - eliminates need for power pack
 - Dim to Off - eliminates need for AC Relay
- Controls agnostic, compatible with a wide range of controls systems

» Solutions

- NB-IoT
- PLC
- DMX-RDM
- Synapse
- ZigBee
- GPRS

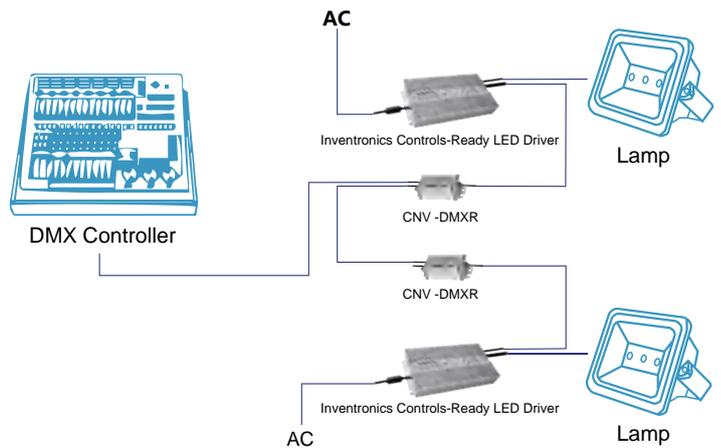

Intelligent Controllers

DMX-RDM
CNV-DMXR DMX-RDM Stadium/Stage Lighting Management Solution



cUL US FC CB CE

- Features**
- Converts DMX-RDM Signal to 0-10V Dimming Signal
 - Compatible with RDM over DMX512 Networks with Bi-Directional Communication

CNV-ZIGB Daintree Networks Integrating Wireless Control



cUL US FC CE

- Features**
- Converts Daintree Networks Signal to 0-10V Dimming Signal
 - Compatible with Daintree Networks® ControlScope® Building Energy Management System

Synapse
CNV-SNAP-ANO Synapse Networks Integrating Wireless Control



cUL US FC CE

- Features**
- Synapse to 0-10V Network Interface Module
 - Deployed and managed using Synapse SimplySNAP software
 - Typical Application: Stadium, Production and Architectural Lighting

Programming Tools

PRG-MUL2
Features



- Programmer for all Inventronics DALI and 0-10v programmable drivers
- Supports TDD-ANPNx and SDD-AAPNx
- Offline Programing Capability
- Automatic Programming Mode

PRG-CASE2
Features



- Ruggedized case for the PRG-MUL2
- For use in manufacturing environments
- LED Indicator and built-in buzzer for programming status
- Quick Connect terminals for ease of connection
- Long life user interface button to deploy program to drivers



PU-20KS10KHT

■ Features

- Compatible with Inventronics LED Drivers
- 90-305 Vac Working Input Voltage
- DM , CM Surge Protection Mode
- Maximum Discharge Current (Imax) 20kA, 8/20µs
- Nominal Discharge Current (In) 10kA, 8/20µs
- UL1449 Type 5 Recognized Component
- IEEE C62.41 2 Location Category C High Exposure
- High Temperature, 85 °C Maximum Surface Temp Rating



PS-20KS10KHT

■ Features

- Compatible with Inventronics LED Drivers
- 249-528 Vac Working Input Voltage
- DM , CM Surge Protection Mode
- Maximum Discharge Current (Imax) 20kA, 8/20µs
- Nominal Discharge Current (In) 10kA, 8/20µs
- UL1449 Type 5 Recognized Component
- IEEE C62.41 2 Location Category C High Exposure
- High Temperature, 85 °C Maximum Surface Temp Rating



PU-20KX10KTXX

■ Features

- Compatible with Inventronics LED Drivers
- 90-305 Vac Working Input Voltage
- 15 kA Maximum, 10 kA Nominal (15 strikes) Surge Current Rating Using Industry Standard 8/20µs Wave
- UL1449 Type 4, EN 61643-11 – Surge Protective Devices T2 & T3
- IEEE C62.41.2 Location Category C High
- High Temperature, 85 °C Maximum Ambient
- Flameproof Plastic Enclosure
- IP66

INVENTRONICS (HANGZHOU), INC.

Inventronics Science and Technology Park,
#459 Jianghong Road, Binjiang District,
Hangzhou, Zhejiang, China, 310052
Tel: +86-571-56565800
Fax: +86-571-86601139
E-mail: sales@inventronics-co.com

INVENTRONICS EUROPE B.V.

Steenstraat 16, 5107NE Dongen,
The Netherlands
Tel: +31-857-470-061
Fax: +31-857-470-062
E-mail: eu-sales@inventronics-intl.com

INVENTRONICS SOUTH EAST ASIA OFFICE

Singapore
Tel: +65-9180-5200
E-mail: sea-sales@inventronics-co.com

INVENTRONICS BRAZIL OFFICE

Barueri/SP
Tel: +55(11)2680-8310
E-mail: brazilsales@inventronics-intl.com

INVENTRONICS USA, INC.

2825 S Tulsa Ave.
Oklahoma City, OK 73108 USA
Tel: +1-405-600-7480
Fax: +1-405-600-9715
E-mail: usa-sales@inventronics-co.com

INVENTRONICS SSL INDIA PRIVATE LIMITED

Kagalwala House, Plot -175, CST Road, Kalina, Santacruz (East),
Mumbai, India
Tel: +91-98-2154-2220
E-mail: in-sales@inventronics-co.com

INVENTRONICS EAST ASIA OFFICE

603, Chonggu Bluevill, 11-1 Sunae-Dong,
Bundang-gu, Sungnam-si, Gyunggi-do, Korea
Tel: +82-70-7760-1296
E-mail: kr-sales@inventronics-co.com



www.inventronics-co.com